

D. Oscillators

The invention of the **electronic oscillator** was one of the most important steps in creating modern radio.

Q: *Guess who invented it?*

A: Edwin Howard Armstrong!

HO: Oscillators-A Brief History

HO: Oscillators

Oscillators, like all other devices we have studied have many **non-ideal** properties.

HO: Harmonics, Spurs, and dBc

Another non-ideal property of oscillators is **instability**. To understand fully this property, we need to re-discuss what you **think** you know about **phase** and **frequency**!

HO: Phase and Frequency

HO: Oscillator Stability

Perhaps the **most** important, but **least** understood characteristic of any oscillator is an instability known as **phase noise**.

HO: Phase Noise

For a such a **simple** device, an oscillator has **many** potential problems. Among some others are frequency **pushing** and frequency **pulling**.

HO: Pushing and Pulling

Let's **summarize** what we've learned:

HO: The Oscillator Spec Sheet

Oscillators - A Brief History

In September of 1912, **Edwin Howard Armstrong** was experimenting with Lee DeForest's new device—the **audion** (what we now call the **triode vacuum tube**).

These devices had been successfully used as an **AM detector**, but no one (especially DeForest!) quite knew how or why the device worked, or what other **applications** of the device there might be.

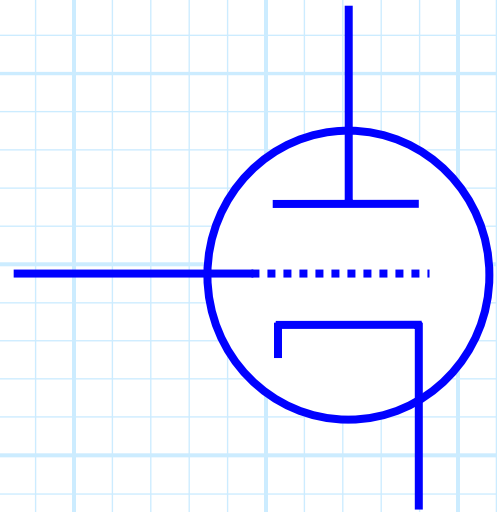

*The Triode
Vacuum Tube*

By coupling one terminal of the device to another, Armstrong found that he could achieve large signal **gain**—he had built the first **electronic amplifier**! He called the process "**regeneration**"; we know it today as positive **feedback**.

The electronic amplifier would **revolutionize** radio, but Armstrong was **not yet finished**!

Armstrong found that as he **adjusted** his amplifier to achieve **maximum** gain, the circuit would suddenly begin to “squeal”. Of course, this was disappointing at first, but then Armstrong realized this “squeal” was a high-frequency signal—the circuit was **oscillating!**

Armstrong had of course increased his feedback to the point that the circuit had become **unstable**—his poles were in the **right-half** plane!

Doh!



Armstrong had made the first **electronic oscillator**—this too would revolutionize radio!

Armstrong had created the components necessary to make **Continuous Wave (CW)** radio **practicable**. Recall that radio at that time was primarily wireless **telegraphy** (i.e., dots and dashes). CW radio is required to transmit **audio** information (e.g., music and voice).



Engineers had **already** created some CW radio systems, using **electromechanical** oscillators, but they could create signals only in the kHz range at best.

With Armstrong's oscillator, CW signals at high frequencies (e.g. kHz and **MHz**) could be **easily** generated!

Along with the **amplifier**, the electronic **oscillator** allowed for the creation of **reliable**, "**low-cost**" radio systems with **clear** and **audible** sound!

Although these inventions gave a **tremendous** boost to the radio industry, a major technical problem still remained.

But guess what? Armstrong would solve **this** problem too!

ARMSTRONG, EDWIN HOWARD (Dec. 18, 1890 -- Jan. 31, 1954), electrical engineer and inventor of three of the basic electronic circuits underlying all modern radio, radar, and television, was born in New York City, the first child of John and Emily Smith Armstrong, both native New Yorkers. His mother had been a teacher in the public schools and his father was vice president of the United States branch of the Oxford University Press. The family soon moved to the suburban town of Yonkers, N.Y., where they lived in a house on a bluff overlooking the Hudson River.

Armstrong decided to become an inventor when he was fourteen and began filling his bedroom with a clutter of homemade wireless gear. His imagination was fired by the *Boy's Book of Inventions* and by Guglielmo Marconi, who a few years before had sent the first wireless signals across the Atlantic. But wireless telegraphy was still in a primitive state. Its crude spark-gap transmitters produced electromagnetic wave signals so weak that sunlight washed them out through most daytime hours, while its iron-filing or magnetic receivers were cruder still, requiring tight earphones and quiet rooms to catch the faint Morse code signals that were all the early wireless was capable of transmitting. As a student at Yonkers High School (1905-1910), Armstrong built an antenna mast, 125 feet tall, on the family lawn to study wireless in all its aspects. He worked with every new device that came along, among them the so-called audion tube invented in 1906 by Lee deForest. But none of the instruments were able to amplify weak signals at the receiver, nor yet to provide stronger, more reliable power at the transmitter. On graduating from high school, Armstrong began to commute by motorcycle to Columbia University's school of engineering to pursue his studies further.



While a junior at Columbia, Armstrong made his first major invention. Long analysis of the action within the audion tube suggested to him that it might be used to greater effect. The tube was based upon Thomas Edison's 1883 discovery in his early lamp of a tiny anomalous electric current that flowed across a gap from the filament to a metal plate. In 1904 an English inventor, John Ambrose Fleming, had shown that this effect could be used as a wireless receiver, two years later deForest had added a vital element, a wire grid between the filament and plate. But in the usual receiver circuit the tube did no more than detect weak signals. In the summer of 1912 Armstrong devised a new regenerative circuit in which part of the current at the plate was fed back to the grid to strengthen incoming signals. Testing this concept in his turret room in Yonkers, he began getting distant stations so loudly that they could be heard without earphones. He later found that when feedback was pushed to a high level the tube produced rapid oscillations acting as a transmitter and putting out electromagnetic waves. Thus this single circuit yielded not only the first radio amplifier but also the key to the continuous-wave transmitter that is still at the heart of all radio operations.

Armstrong received his engineering degree in 1913, filed for a patent, and returned to Columbia as an instructor and as assistant to the professor and inventor, Michael Pupin. Before his new circuit could gain wide use, however, awaiting improvements in the vacuum tube, the United States was plunged into World War I and Armstrong was commissioned as an officer in the U.S. Army Signal Corps and sent to Paris. He was assigned to detect possibly inaudible shortwave enemy communications and thereby created his second major invention. Adapting a technique called heterodyning found in early wireless, but little used, he designed a complex eight-tube receiver that in tests from the Eiffel Tower amplified weak signals to a degree previously unknown. He called this the superheterodyne circuit, and although it detected no secret enemy transmissions, it is today the basic circuit used in 98 percent of all radio and television receivers.

Armstrong returned to Columbia with the rank of major and the ribbon of France's Legion of Honor. By then, wireless was ready to erupt into radio broadcasting. In 1920, on a bid from Westinghouse Electric and Manufacturing Company, he sold rights to his two major circuits for \$335,000.00. Later he sold a lesser invention, the superregenerative circuit, to the newly organized Radio Corporation of America (RCA) for a large block of stock. Upon the success of early radio broadcasting, he became a millionaire, but he continued at Columbia University as a professor and eventual successor to Pupin. After a celebratory trip to Paris, he returned to court Marion MacInnes, secretary to the president of RCA, David Sarnoff. On Dec. 1, 1923 they were married.

As the 1920's wore on, Armstrong found himself enmeshed in a corporate war to control radio patents. His basic feedback patent had been issued on Oct. 6, 1914. Nearly a year later deForest filed for a patent on the same invention, which he sold with all audion rights to the American Telephone and Telegraph Company (AT & T). As radio began to boom, AT & T mounted a broad attack to overturn Armstrong's patent in favor of deForest's. The battle went through a dozen courts between 1922 and 1934. Armstrong, backed by Westinghouse and RCA, won the first round, lost a second, was stalemated in a third, and finally, in a last-ditch stand before the Supreme Court, lost again through a judicial misunderstanding of the technical facts.

The technical fraternity refused to accept the final verdict. The Institute of Radio Engineers, which in 1918 had awarded Armstrong its first Medal of Honor for the invention, refused in a dramatic meeting to take back the medal. And the action was reaffirmed in 1941 when the Franklin Institute, weighing all the evidence, gave Armstrong the highest honor in U.S. science, the Franklin Medal.

Throughout this ordeal Armstrong doggedly continued to pursue his research. He had early set out to eliminate the last big problems of radio -- static. Radio then carried the sound patterns by varying, or modulating, the amplitude (power) of its carrier wave at a fixed frequency (wavelength) -- a system easily and noisily broken into by such amplitude phenomena as electrical storms. By the late 1920's Armstrong had decided that the only solution was to design an entirely new system, in which the carrier-wave frequency would be modulated, while its amplitude was held constant. Undeterred by current opinion -- which held that this method was useless for communications -- Armstrong in 1933 brought forth a wide-band frequency modulation (FM) system that in field tests gave clear reception through the most violent storms and, as a dividend, offered the highest fidelity sound yet heard in radio.

But in the depressed 1930's the major radio industry was in no mood to take on a new system requiring basic changes in both transmitters and receivers. Armstrong found himself blocked on almost every side. It took him until 1940 to get a permit for the first FM station, erected at his own expense, on the Hudson River Palisades at Alpine, N.J. It would be another two years before the Federal Communications Commission granted him a few frequency allocations.

When, after a hiatus caused by World War II, FM broadcasting began to expand, Armstrong again found himself impeded by the FCC, which ordered FM into a new frequency band at limited power, and challenged by a coterie of corporations on the basic rights to his invention. Facing another long legal battle, ill and nearly drained of his resources, Armstrong committed suicide on the night of Jan. 31, 1954, by jumping from his apartment window high in New York's River House. Ultimately his widow, pressing twenty-one infringement suits against as many companies, won some \$10 million in damages. By the late 1960's, FM was clearly established as the superior system. Nearly 2,000 FM stations spread across the country, a majority of all radio sets sold are FM, all microwave relay links are FM, and FM is the accepted system in all space communications.

Armstrong was posthumously elected to the roster of electrical "greats" to stand beside such figures as Alexander Graham Bell, Marconi, and Pupin, by the International Telecommunications Union in Geneva. He was the great prose master of electronic circuitry, weaving its phrases and components into magical new forms and meanings.

by Lawrence P. Lessing. Originally published in *Dictionary of American Biography, Supplement Five*, pp. 21 - 23; Charles Scribner Sons, New York.

Oscillators

Generally speaking, we construct an oscillator using a **gain device** (e.g., a transistor) and a **resonator**.

Examples of resonators include **LC networks**:

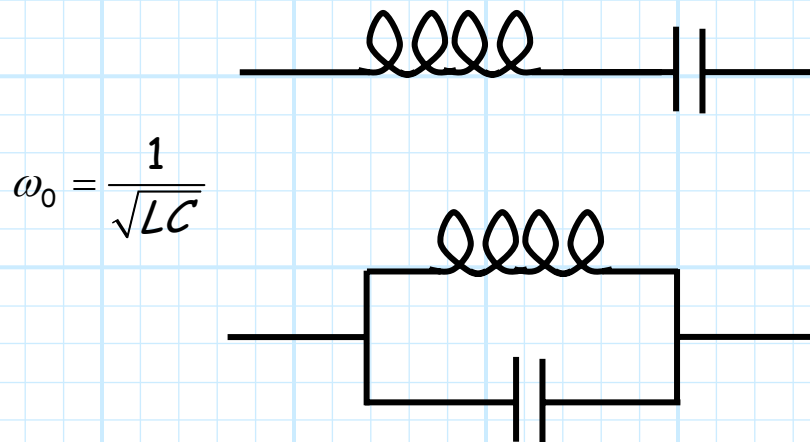

To make an oscillator, we basically take the **output** of an amplifier and “feed it back” (i.e., feedback), **through** the resonator, to the **input** of the gain device.

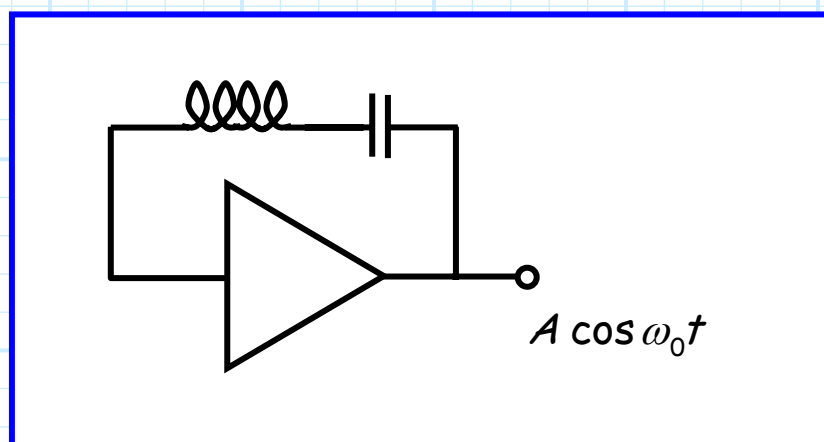

Under the proper conditions, this device will be **unstable**—it will **oscillate!**

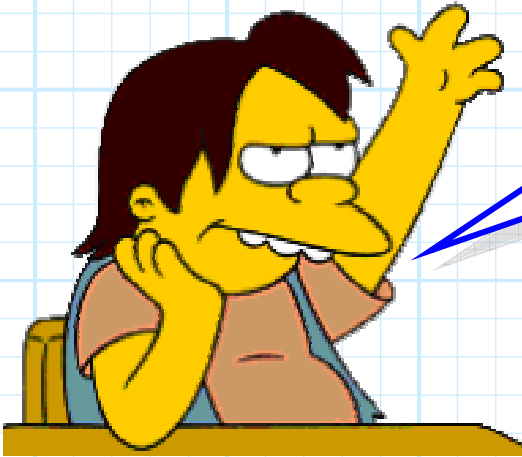

Q: *But at what signal frequency ω_0 will an oscillator oscillate?*

A: Every resonator has a **resonant frequency**. The oscillator will oscillate at **this** frequency!

The good news: a **perfect** resonator will resonate precisely at frequency ω_0 .

The bad news: there are **no** perfect resonators! Therefore, the oscillating frequency of an oscillator is a bit **ambiguous**.

A **spectral analysis** (e.g., power vs. frequency) of an oscillator output reveals that energy is **spread** over a range of frequencies centered around ω_0 , rather than **precisely** at frequency ω_0 .

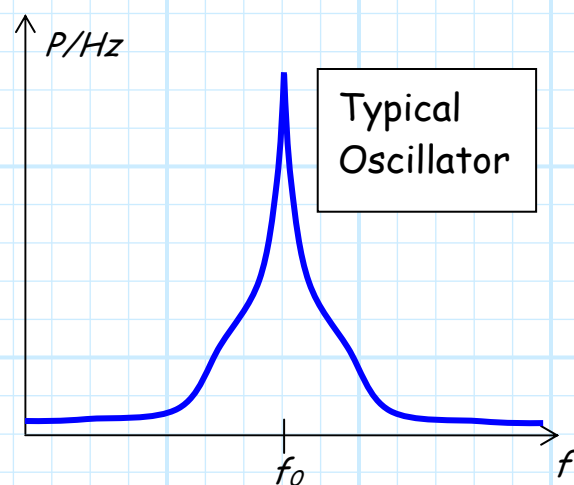
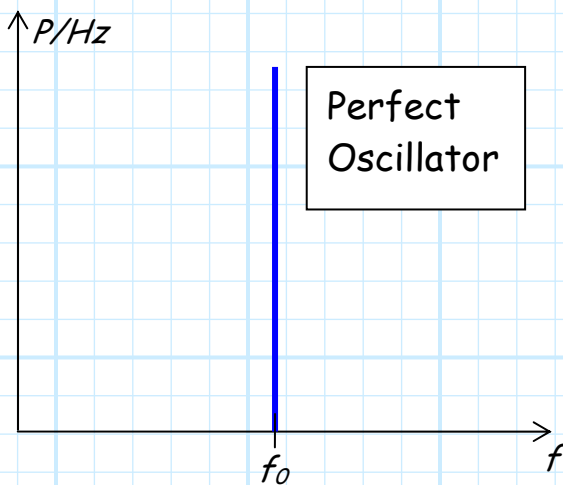

- * The "bandwidth" of this output spectrum is related to the **quality** of the resonator.
- * A **high-Q** resonator provides a spectrum with a **narrow** width (i.e., spectrally pure).
- * A **low-Q** resonator provides an output with a **wider** spectral width.
- * Generally, low-Q resonators are **lossy**, where as high-Q resonators exhibit **low loss**!

LC networks are generally quite lossy, and thus low-Q!

Q: *Yikes! Are there any high-Q resonators available for constructing microwave oscillators?*

A: *Of course! Among my favorite resonators are **crystals** and **dielectric cavities**.*

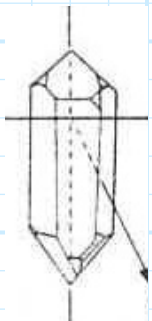

Crystal Resonators: Like the name suggests, these devices are in fact **crystals** (e.g. Quartz). The resonant frequency of a crystal resonator is dependent on its **geometry** and its atomic **lattice** structure. These resonators are typically used for **RF** oscillators, where signal frequency is less than 2 GHz.

Dielectric Cavity Resonator - Cavity resonators have a resonant frequency that is dependent on the **cavity geometry**. Dielectric cavities are popular since they have low loss and can be made very **small**. Oscillators made with these devices are called **Dielectric Resonance Oscillators**, or **DROs**. Typically, these resonators will be used for **microwave** oscillators, at frequencies greater than 2 GHz.



Transmission Line Resonator - We can also make a resonator out of **transmission line** sections. Typically, these are used in stripline or **microstrip** designs (as opposed to coaxial). Technically, these are **LC resonators**, as we utilize the inductance and capacitance of a transmission line. As a result, transmission line resonators typically have a **lower Q** than crystals or cavities, although they exhibit lower loss than "lumped" element LC resonators.

Q: *So, would we ever use a lumped LC network in a RF/microwave oscillator design?*

A: Actually, there is **one** application where we almost certainly **would!** The main drawback of the resonators described above is that they are **fixed**.

In other words they cannot be tuned!

If we wish to **change** the oscillating frequency ω_0 , we must change (i.e., **tune**) the resonator.

This is **tough** to do if the resonant frequency depends on the **size** or **shape** of the resonator (e.g., crystals and cavities)!

Instead, we might use a **lumped LC** network, where the capacitor element is actually a **varactor diode**:

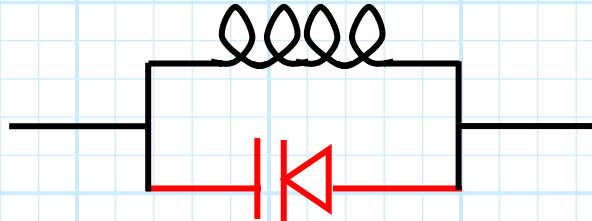

A varactor diode is a *p-n* junction diode whose **junction capacitance** (C_j) varies as a function of **diode voltage** (v_D), when **reversed** biased. E.G.:

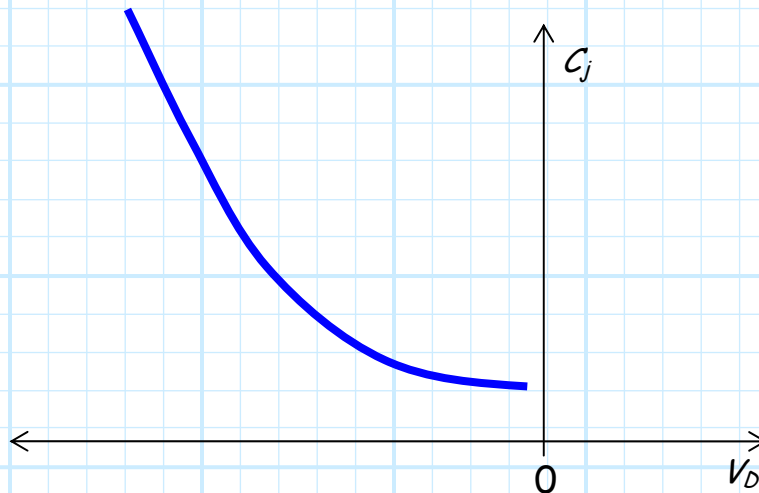

Thus, by **changing** the diode (reverse) bias voltage, we **change** the capacitance value, and thus **change** the resonate (i.e., oscillator) frequency:

$$\omega_0(v_D) = \frac{1}{\sqrt{LC(v_D)}}$$

We call these oscillators **Voltage Controlled Oscillators (VCOs)**.

Q: *Just exactly why would we ever **want** to change an oscillator's frequency?*

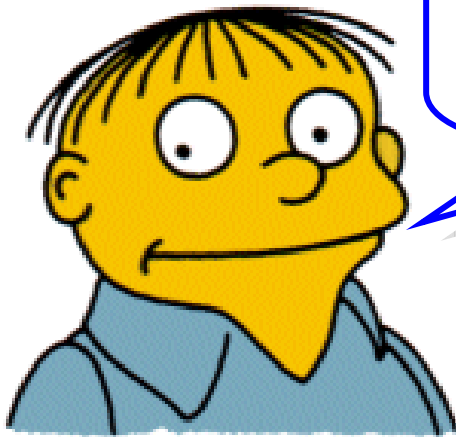

A: We'll soon discover that a **tunable** oscillator is a critical component in a **super-heterodyne** receiver design!

Harmonics, Spurs, and dBc

In addition to the carrier signal at frequency ω_0 , an oscillator will produce **many** other signals!

For example, an oscillator generally creates **harmonics**:

I.E., signals at $2\omega_0$, $3\omega_0$, etc.

Additionally, an oscillator may output signals at other **arbitrary** frequencies. We call these **spurious** signals, or "spurs".

The carrier signal has, of course, some **power** we denote as P_C .

Generally speaking, the power of the **harmonics** and **spurs** will be significantly **less** than the **carrier** power P_C .

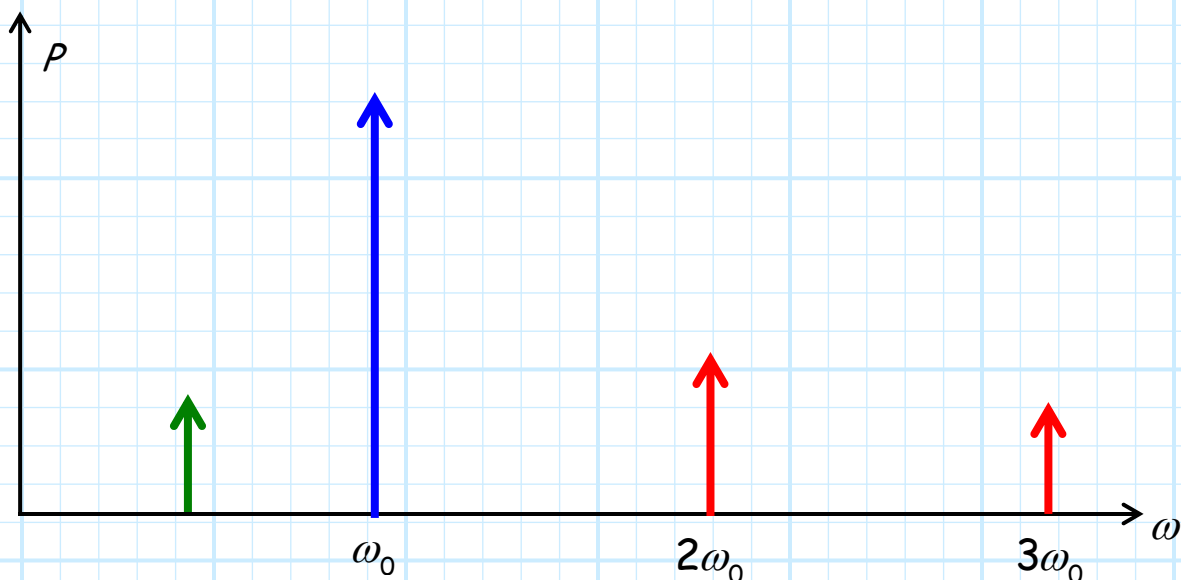

We can of course represent the power of the harmonics and spurs in **dBm** or **dBW**.

However, often what we are interested in is not what that power of the harmonics and spurs are **specifically**, but instead what the power of the harmonics and spurs are in **relation** to the carrier power P_c .

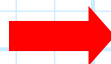
 We want spurs and harmonics to be small in **comparison** to P_c !

Therefore, we define a new **decibel** relationship:

$$\begin{aligned}\text{Power } P \text{ in dBc} &\doteq 10 \log_{10} \left(\frac{P}{P_c} \right) \\ &= P(\text{dBm}) - P_c(\text{dBm}) \\ &= P(\text{dBw}) - P_c(\text{dBw})\end{aligned}$$

For example, if $P_c = 10$ dBm and the power of the first harmonic is -40 dBm, then the power of the first harmonic can be expressed as -50 dBc.

In other words, the first harmonic is **50 dB smaller** than the carrier.

Phase and Frequency

Consider the functions $\sin x$ or $\cos x$ or e^{jx} .

Q: *What are the units of x ??*

A: The units of x must be radians.

In other words x is phase ϕ , i.e., $\cos \phi$ and $\sin \phi$ and $e^{j\phi}$

Phase can of course be a function of time, i.e., $\cos \phi(t)$. For example:

$$\cos(\omega_0 t + \phi_0)$$

In other words, the signal **phase** $\phi(t)$ is $\phi(t) = \omega_0 t + \phi_0$!

Q: *What the !?! I always thought "phase" was ϕ_0 , not $\omega_0 t + \phi_0$!*

A: Time for some definitions!



We call $\phi(t) = \omega_0 t + \phi_0$ the **total**, or absolute phase of the sinusoidal signal. Note the **total** phase is a **linearly increasing** function of time!

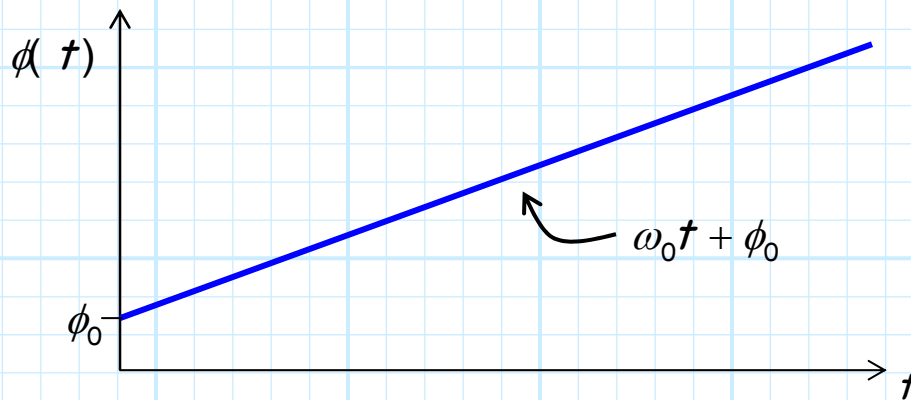

The **slope** of this line is ω_0 , while the **y-intercept** is ϕ_0 .

We can define the **relative phase** $\phi_r(t)$ as:

$$\phi_r(t) = \phi(t) - \omega_0 t$$

Thus, if $\phi(t) = \omega_0 t + \phi_0$, then $\phi_r(t) = \phi_0$.

But, the relative phase need not be a **constant**. In general, we can write:

$$\cos[\omega_0 t + \phi_r(t)]$$

Therefore, the relative phase is in general some arbitrary **function of time**.

Q: *O.K., so you have made **phase** really complicated, but at least the signal **frequency** is still ω_0 , right??*

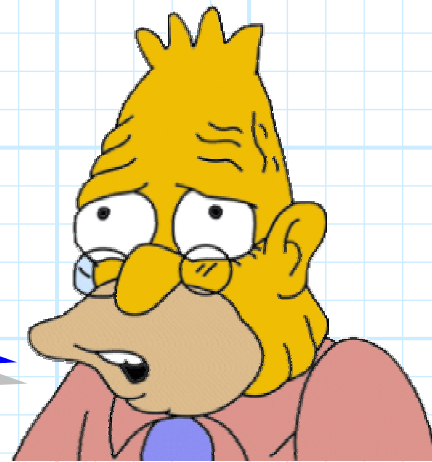

A: **Wrong !** Frequency too is a little more **complicated** than you might have imagined.

Angular frequency is **defined** as the rate of (**total**) phase change with respect to time. As a result, it is measured in units of **radians/second**.

How do we **determine** the rate of phase change with respect to time?

 We take the **derivative** of $\phi(t)$ with respect to t !

I.E.,

$$\omega(t) = \frac{d\phi(t)}{dt} \quad (\text{radians/sec})$$

For example, if $\phi(t) = \omega_0 t + \phi_0$, then:

$$\omega(t) = \frac{d(\omega_0 t + \phi_0)}{dt} = \omega_0$$

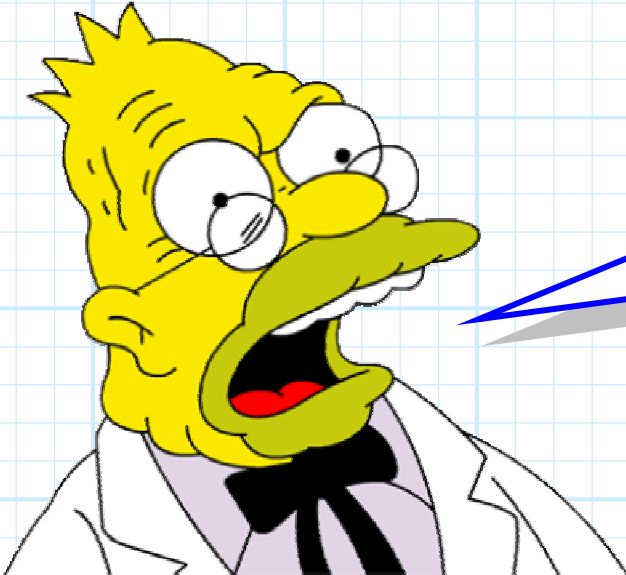

Q: See! I told you! The frequency is ω_0 after all!

A: Not so fast! The frequency (i.e., the rate of phase change) is equal to ω_0 **only** if total phase is $\phi(t) = \omega_0 t + \phi_0$. In other words, the frequency is equal to ω_0 **if the relative phase is a constant ϕ_0** . Otherwise:

$$\begin{aligned} \omega(t) &= \frac{d[\omega_0 t + \phi_r(t)]}{dt} \\ &= \frac{d(\omega_0 t)}{dt} + \frac{d\phi_r(t)}{dt} \\ &= \omega_0 + \frac{d\phi_r(t)}{dt} \\ &= \omega_0 + \omega_r(t) \end{aligned}$$

In other words, the **total frequency** $\omega(t)$ is the sum of the **carrier frequency** ω_0 and the **relative frequency** $\omega_r(t)$.

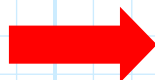
 The **signal frequency** can change with time !

Remember, we can also express frequency in **cycles/second** (i.e., Hz) if we divide by 2π .

$$f(t) = \frac{\omega(t)}{2\pi} \quad (\text{Hz})$$

Therefore, we can write:

$$f(t) = f_0 + f_r(t)$$

Oscillator Stability

In addition to noise, spurs, and harmonics, oscillators have a problem with frequency/phase **instability**.

I.E., a better model for the oscillator signal is:

$$v_c(t) = A_c \cos[\omega_0 t + \phi_r(t)]$$

where $\phi_r(t)$ is a **random process** !

Note then the frequency will likewise be a random process:

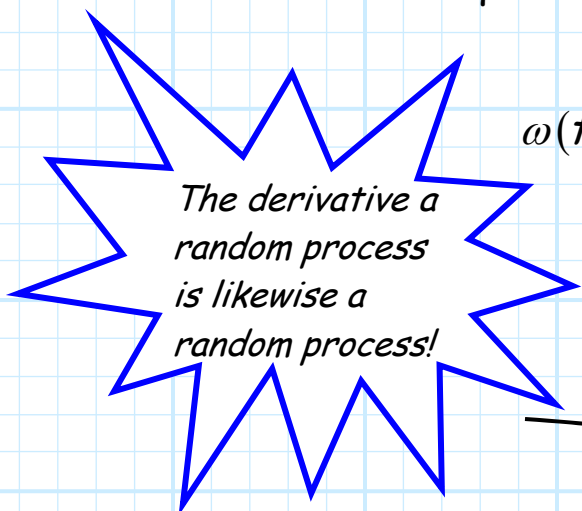

$$\begin{aligned} \omega(t) &= \frac{d[\omega_0 t + \phi_r(t)]}{dt} \\ &= \omega_0 + \frac{d\phi_r(t)}{dt} \\ &= \omega_0 + \omega_r(t) \end{aligned}$$

In other words, the frequency of an oscillator will **vary** slightly with time.

We refer to these random variations as oscillator instability, and these instabilities come in two general types:

1) **Long term instabilities** - These are **slow** changes in oscillator frequency over time (e.g., minutes, hours, or days), generally due to **temperature** changes and/or oscillator **aging**. For good oscillators, this instability is measured in **parts per million (ppm)**.



Parts per million is similar to describing the instability in terms of **percentage** change in oscillator frequency. However, instead of expressing this change relative to one **one-hundredth** of the oscillator frequency ω_0 (i.e., one **percent** of the oscillator frequency), we express this change relative to one **one-millionth** of the oscillator frequency ω_0 !

A more direct way of interpreting "parts per million" is "**Hz per MHz**"—in other words the amount of frequency change $\Delta\omega_r$ in **Hz**, divided by the frequency ω_0 expressed in **MHz**.

For **example**, say an oscillator operates at a frequency of $f_0 = 100 \text{ MHz}$. This oscillator frequency will (slowly) change as much as $\Delta f_r = \pm 10 \text{ kHz}$ over time. We thus say that the **long-term stability** of the oscillator is:

$$\frac{\Delta f_r (\text{Hz})}{f_0 (\text{MHz})} = \frac{\pm 10,000}{100} = \pm 100 \text{ ppm}$$

Slow term stability describes the **accuracy** of the oscillator!

2) Short-term instabilities - The short-term instabilities of oscillators are commonly referred to as **phase noise**—a result of having **imperfect resonators!**

With phase noise, the random process $\phi_r(t)$ has very **small magnitude**, but changes very **rapidly** (e.g., milliseconds or microseconds). This is equivalent to narrow-band **frequency modulation (FM)**, and the result is a **spreading** of the oscillator signal spectrum.



Phase-noise is a **very** complex phenomenon, yet can be **critical** to the performance (or lack thereof) of a radio receiver. As such, it deserves its very **own** handout!

Phase Noise

There are also **short-term** instabilities (e.g., msec to μsec) in oscillator frequency!

We can model these as:

$$v_c(t) = a \cos[\omega_0 t + \phi_n(t)]$$

where the relative phase $\phi_n(t)$ is a random process called **phase noise**.

Q: *It looks a lot like phase modulation!*

A: Essentially, it is.

The **random** process $\phi_n(t)$ has a small magnitude, *i.e.*:

$$|\phi_n(t)| \ll 1$$

Note since the phase changes as a function of time, the **frequency** will as well! Specifically:

$$\begin{aligned} \omega(t) &= \frac{d(\omega_0 t + \phi_n(t))}{dt} \\ &= \omega_0 + \frac{d\phi_n(t)}{dt} \\ &= \omega_0 + \omega_n(t) \end{aligned}$$

where:

$$\omega_n(t) = \frac{d\phi_n(t)}{dt}$$

As a result, the **frequency** of the oscillator is also a **random** process.

I.E., the oscillator frequency changes randomly as a function of time!

This random fluctuation **spreads** the oscillator signal **spectrum**.

In other words, **instead** of the spectrum of a **perfect**, "pure" tone:

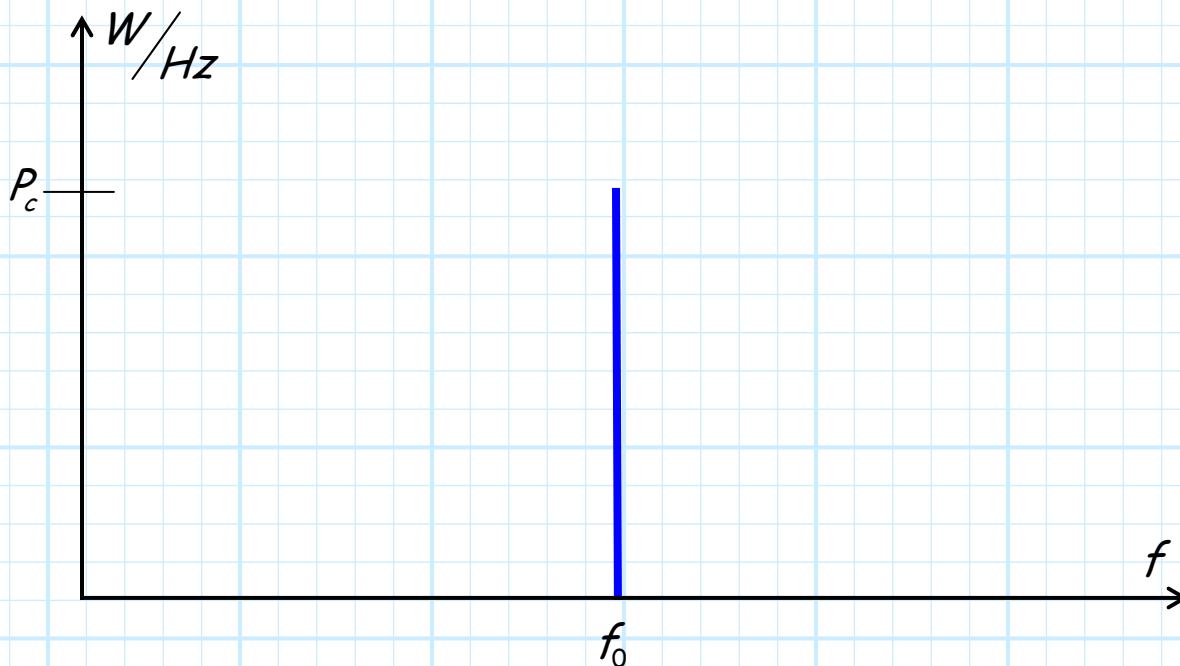

we get a wider, **imperfect** spectrum:

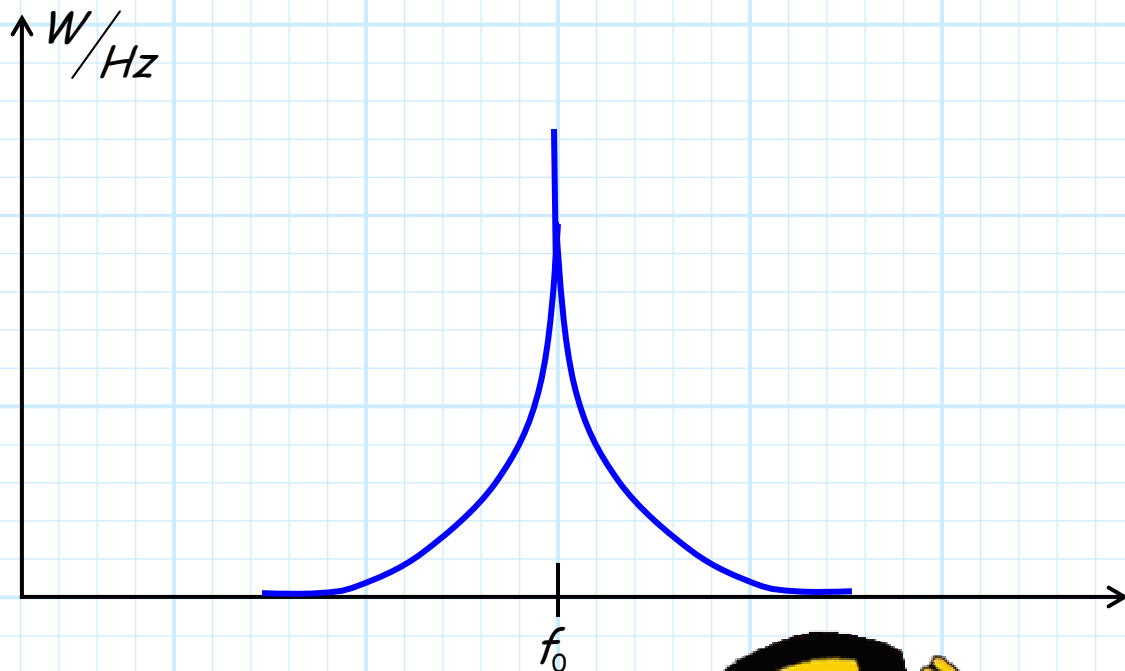

In this case, we say our oscillator has **spectral impurities!**

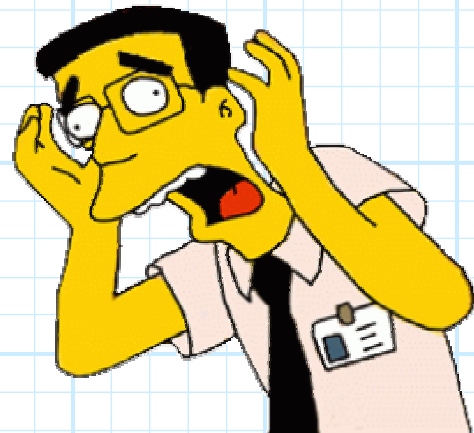

- * Since the phenomenon of phase noise is a random process, we must describe the signal spectrum in terms of its **average** spectral power density.

- * Spectral Power Density is expressed in units of **Watts/Hz**.

- * For **white** noise, the spectral power density is a **constant** with respect to frequency:

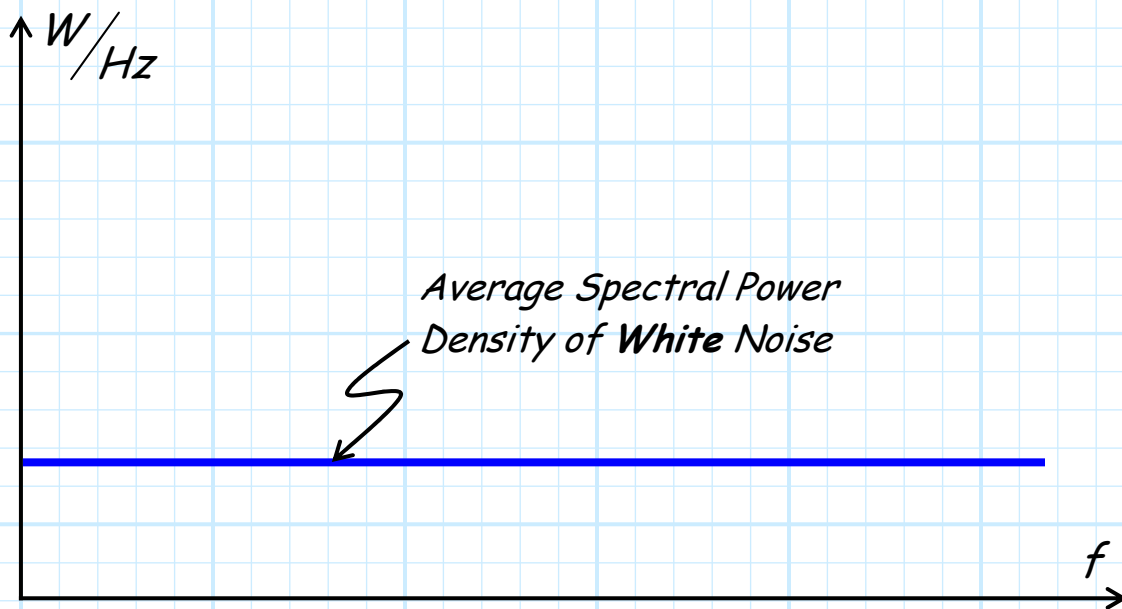

- * However, for **phase** noise, the resulting spectral power density **changes** as a **function** of frequency!

Specifically, the average spectral power density of an oscillator **increases** as frequency f **near**s the nominal signal (i.e., **carrier**) frequency f_0 .

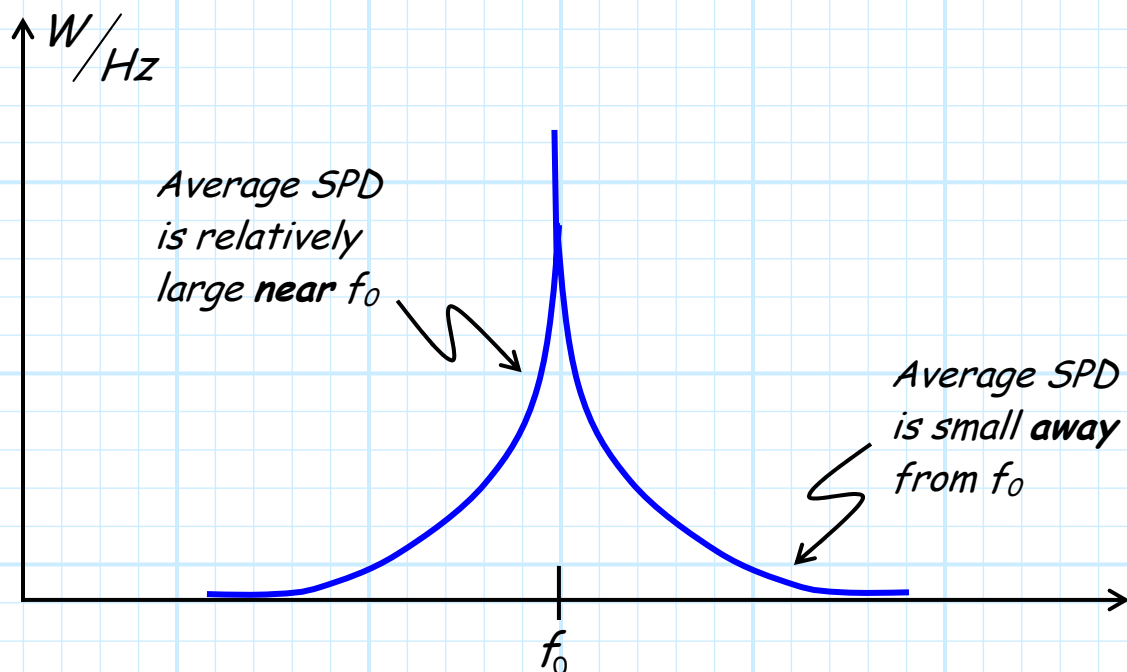

Now, although we typically express average spectral power density in Watts/Hz or dBm/Hz, we generally express the spectral power density of an **oscillator** output in **dBc** !

In other words, we are only concerned about the magnitude of the phase noise spectral power density in **comparison to the oscillator signal power P_c** !

* Note we have a mathematical **problem** here! P_c is in **Watts**, and SPD is in **Watts/Hz**. Therefore, the ratio of the two is **not** unitless!

* We get around this problem by specifying the noise as its power in a **1 Hz bandwidth**.

→ **Numerically**, this is identical to the average spectral power density of the noise!

For **example**, if the noise power has an average spectral power density $2.0 \mu\text{W}/\text{Hz}$, then the noise power in a bandwidth of **1 Hz** is:

$$2.0 \frac{\mu\text{W}}{\text{Hz}} (1 \text{ Hz}) = 2.0 \mu\text{W}$$

Thus, phase noise is expressed as a rather **cumbersome**:

dBc in a 1 Hz bandwidth

Q: But phase noise is a **function** of frequency f . Do we have to **explicitly** specify this function?

A: Generally speaking **no**. Phase noise is generally specified by stating the value of the noise power at **one** or **two** specific frequencies, with **respect** to the carrier frequency f_0 .

Typically, the frequencies where the phase noise is **specified** ranges from 1 KHz to 100 KHz from the carrier.

For example, a **typical** oscillator spec might say:

*-90 dBc in a 1 Hz bandwidth at 1 KHz from the carrier, and
-120 dBc in a 1 Hz bandwidth at 10 KHz from the carrier.*

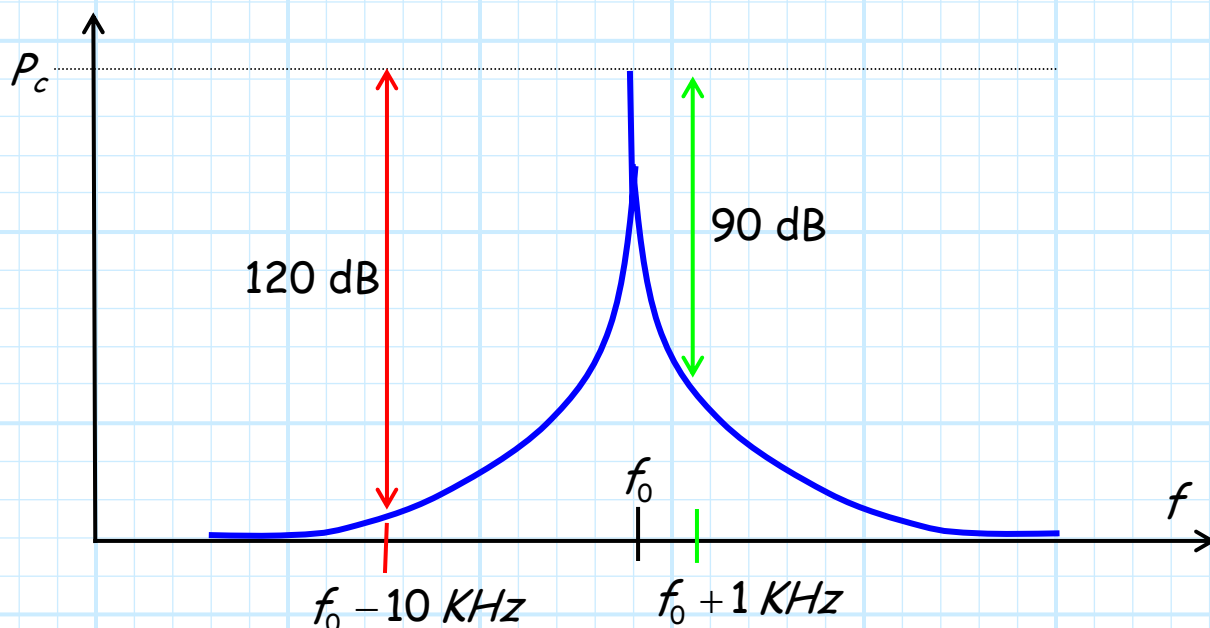

Make sure that **you** know how to properly specify the phase noise of an oscillator. It is **often** incorrectly done, and the source of many **lost points** on an exam or project!

Pushing and Pulling

As if oscillators didn't already have enough **problems** (e.g., spurs, phase noise, frequency drift) we must consider **two** more!

1. Frequency Pushing
2. Frequency Pulling

Let's first tackle **pushing**.

Frequency Pushing

Every oscillator needs a **power supply**! Oscillator output power must come from somewhere—typically, this somewhere is a **D.C. voltage** source.

Unfortunately, the operating frequency ω_0 of an oscillator is **sensitive** to this supply voltage. In other words, as the D.C. supply voltage **changes**, the output frequency can also **change**.

We call this phenomenon **frequency pushing**.

Frequency pushing is expressed in terms of **Hz/V** or **Hz/mV**, and can be **either** a positive or negative value.



For example, consider an oscillator with frequency pushing of **-500 Hz/mV**.

If its power supply voltage increases by **20 mV**, then the operating frequency will **change** by:

$$(20 \text{ mV}) \left(-500 \frac{\text{Hz}}{\text{mV}} \right) = -20,000 \text{ Hz.}$$

In other words, the operating frequency will **drop** by **20 kHz!**

The effect of frequency **pulling** can be **minimized** by:

1. Using a **high-Q** resonator.
2. **Regulating** the power supply voltage **very well**.

The **best** (and thus most expensive) oscillator devices will employ their own **voltage regulator**, right at the **oscillator circuit!**

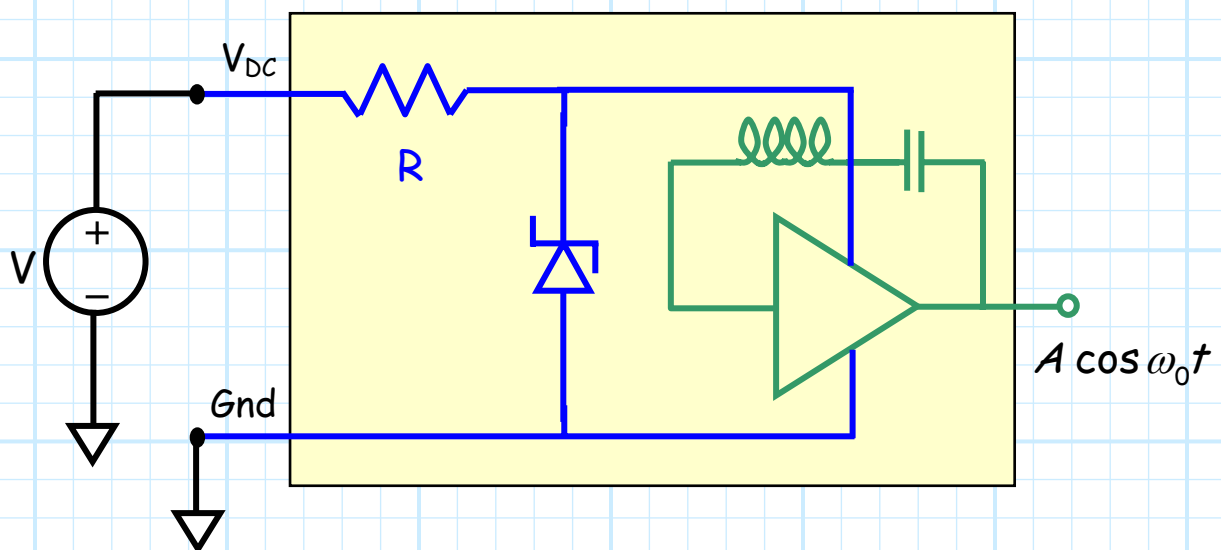

Frequency Pulling

The output of an oscillator will **always** be attached to **something** (otherwise, what's the point?).

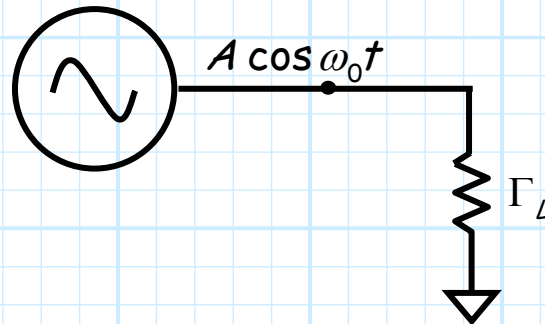

Unfortunately, the **impedance** of this load can affect the operating **frequency** of the oscillator! As Γ_L changes, so can the frequency ω_0 (e.g., $\omega_0(\Gamma_L)$).

This phenomenon is called **frequency pulling**.



The oscillator is designed assuming that the load is **matched**, so that the specified oscillator frequency typically represents the case when $\Gamma_L = 0$.

Frequency pulling is specified as the **maximum deviation** from this nominal frequency, given some **worst case** load.

For example, a frequency pulling **specification** might read:

"less than 2 kHz at VSWR = 2.5"

or

"no more than 5 kHz at 10 dB return loss"

We can minimize frequency pulling by **isolating** the oscillator from the load. Recall that an amplifier typically has very large **reverse isolation**, so that we can use it to **isolate** the oscillator from the load:

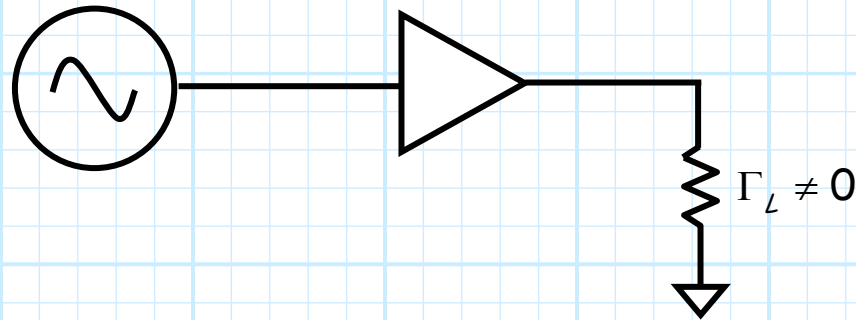

In this case, the oscillator “thinks” it is delivering its power to a **matched** load (the input impedance of the amplifier). The frequency of the oscillator will therefore be its nominal (i.e., matched load) value, even though the load may be poorly matched.

Q: *Why would the load be **poorly** matched? Wouldn't we want to deliver the oscillator power to some **matched** device, like a coupler or amplifier or filter?*

A: Actually, one of the most **common** devices that an oscillator finds itself attached to is the **Local Oscillator (LO)** port of a **mixer**—a port that has a **notoriously poor** return loss.

Frequency pulling can be a real **problem!**

The Oscillator Specification Sheet

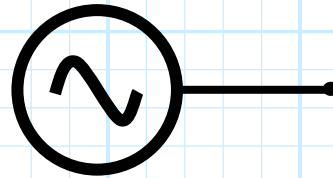

Carrier Frequency

Generally specified in Hertz (Hz).

Electronic oscillators have been made that work well into the **millimeter** wave region (e.g., 100 GHz), but we typically find that **increasing** the oscillating frequency means **decreased** oscillator performance (e.g., **lower power, less stability**) and increased oscillator **cost**!

Carrier Power

Generally specified in dBm for **low-power** oscillators, Watts for **high-power** oscillators.

Typical values for "small-signal" oscillators are **5 to 20 dBm** (hey, the same values as for **mixer LO** drive power—what a coincidence!).

Stability

Specified in **ppm** over the temperature range of the device (e.g., -25°C to 85°C). This value is usually considered the **accuracy** of the oscillator.

Phase Noise

Specified in **dBc** in a **one Hz bandwidth** at one or more specific frequencies **from the carrier**.

e.g., *-80 dBc in a 1Hz bandwidth at 1 kHz from the carrier frequency f_0*

Every single word in this specification is **required** in order to unambiguously specify phase noise!!!

The amount of phase noise exhibited by an oscillator depends on the **Q of the resonator**, the **carrier frequency** (higher frequencies generally exhibit worse phase noise), and the amount of **noise coupled** into the device through the power supply or tuning port.

Frequency Pushing

Expressed in units of *Hz/V* or *Hz/mV*. Can be **either** a positive or a negative number.

This value depends on the **Q of the resonator**, the **carrier frequency** (higher frequencies generally exhibit worse pushing), and the amount of **internal voltage regulation** built into the oscillator.

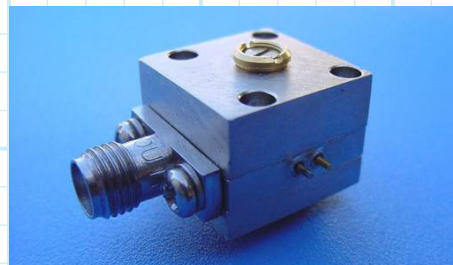

Frequency Pulling

Specified as the maximum frequency shift from nominal frequency ω_0 , due to some worst-case load (expressed in VSWR, return loss, etc.). For example:

*Pulling is less than 0.1 MHz when driving a 2.5:1 VSWR load. This value again depends on the **Q of the resonator** and the **carrier frequency** (higher frequencies generally exhibit worse pulling). It likewise depends on the amount of **isolation** provided between the oscillator and its output port.*

Harmonics and Spurs

Typically specified as the power of the **largest** spurious and/or harmonic signal, typically in terms dBc. For example:

All spurious signal are less than -50 dBc

This value depends on the quality **Q** of the resonator, as well as the amount of **filtering** provided between the oscillator and its output port.

Noise

This is the thermal noise (as opposed to phase noise) at the output of the oscillator. It is specified in terms of its **spectral power density**, assumed to be **constant** value in Watts/Hz.